

1

2



3

4

RevNo	Revision note	Date	Designed	Checked	Approved

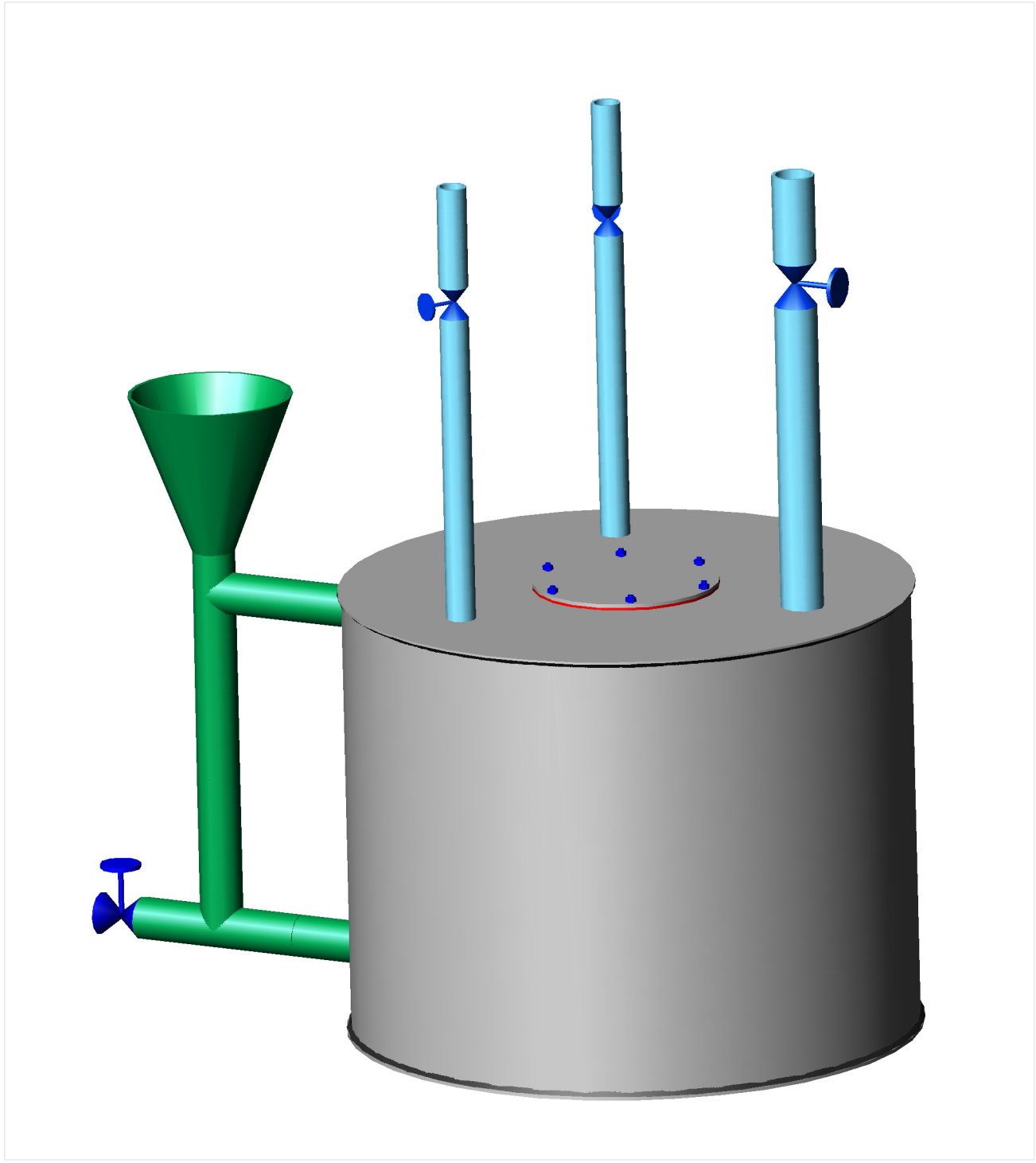
# VISTA 3D



Itemref	Quantity	Title/Name, designation, material, dimension etc			Article No./Reference	
Designed by A. Carrea	Checked by E. Arato	Approved by - date Pongiglione - 30/06/08	File name Genvap	Date 30/06/08	Scale N/A	
  			<h2>Generatore di Vapore</h2>			
010-1-I-GDV-DGC-A				Edition 0	Sheet 1/9	

1

4

1

2

3

4

RevNo	Revision note	Date	Designed	Checked	Approved

# VISTA DI FRONTE

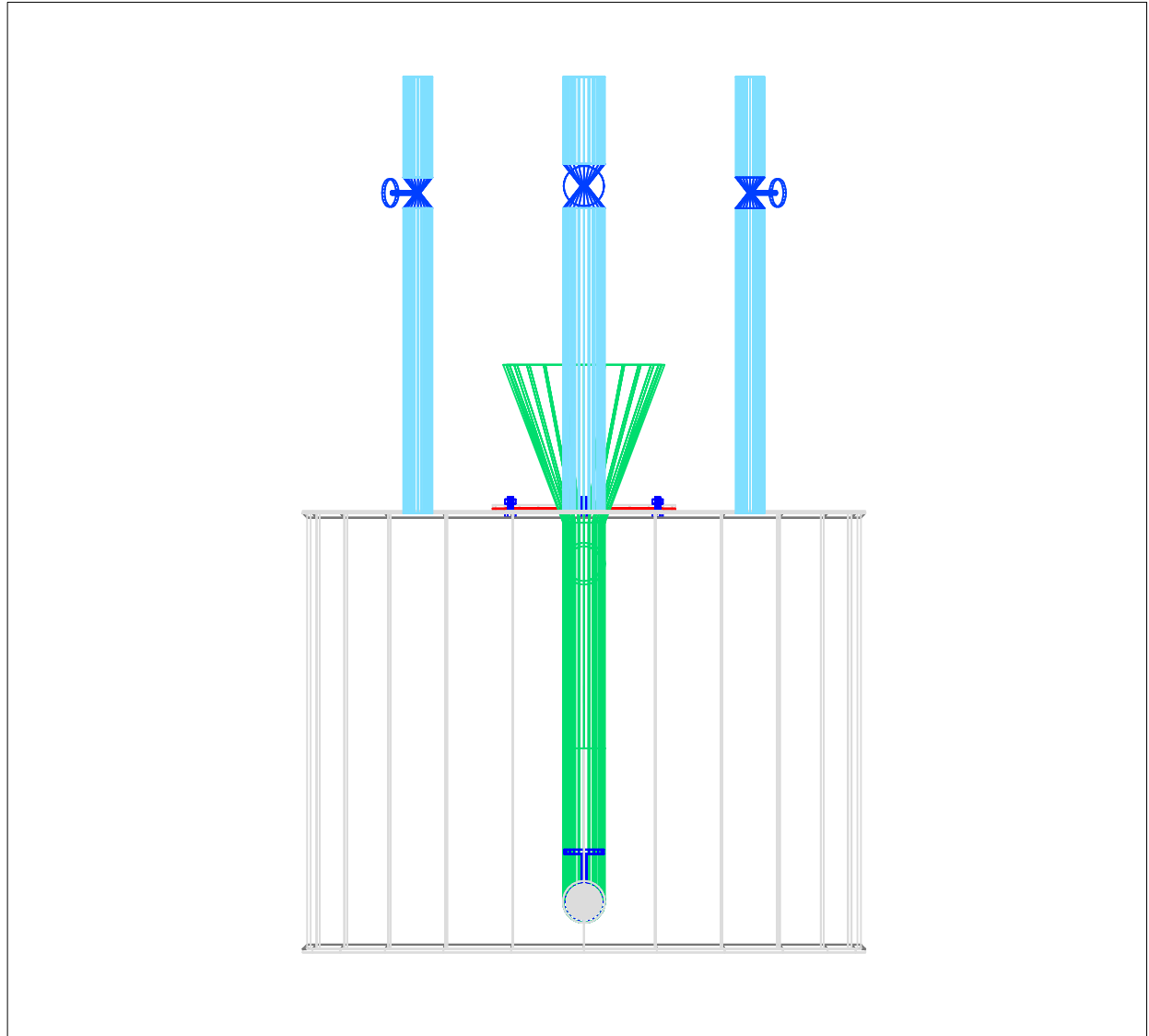

Itemref	Quantity	Title/Name, designation, material, dimension etc		Article No./Reference	
Designed by A. Carrea	Checked by E. Arato	Approved by - date Pongiglione - 30/06/08	File name Genvap	Date 30/06/08	Scale 1:8
			<h2>Generatore di Vapore</h2>		
			010-1-I-GDV-DGC-A	Edition 0	Sheet 3/9

1

4

1

2

3



4

RevNo	Revision note	Date	Designed	Checked	Approved

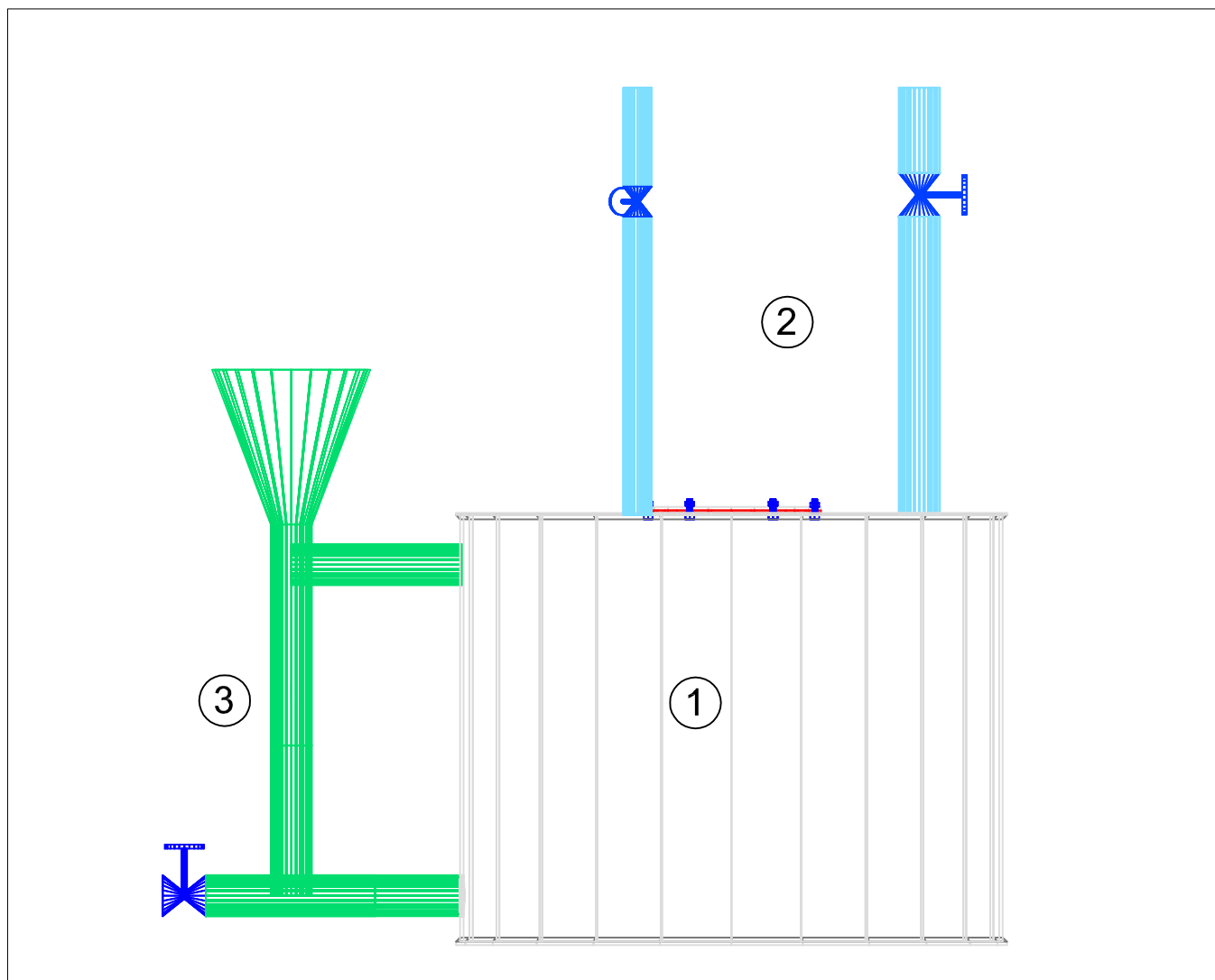
## VISTA DI LATO



ITEM	QUANTITA'	DESCRIZIONE	NOTE
1		Fasciame (lamiera calandrata)	Vedi foglio 5
2		Uscita vapore	Vedi foglio 7
3		Drenaggio, livello e riempimtno	Vedi foglio 8

Itemref	Quantity	Title/Name, designation, material, dimension etc		Article No./Reference	
Designed by A. Carrea	Checked by E. Arato	Approved by - date Pongiglione - 30/06/08	File name Genvap	Date 30/06/08	Scale 1:8
 PS76 ONLUS			<b>Generatore di Vapore</b>		
			010-1-I-GDV-DGC-A	Edition 0	Sheet 2/9

1

4

1

2



3

4

RevNo	Revision note	Date	Designed	Checked	Approved

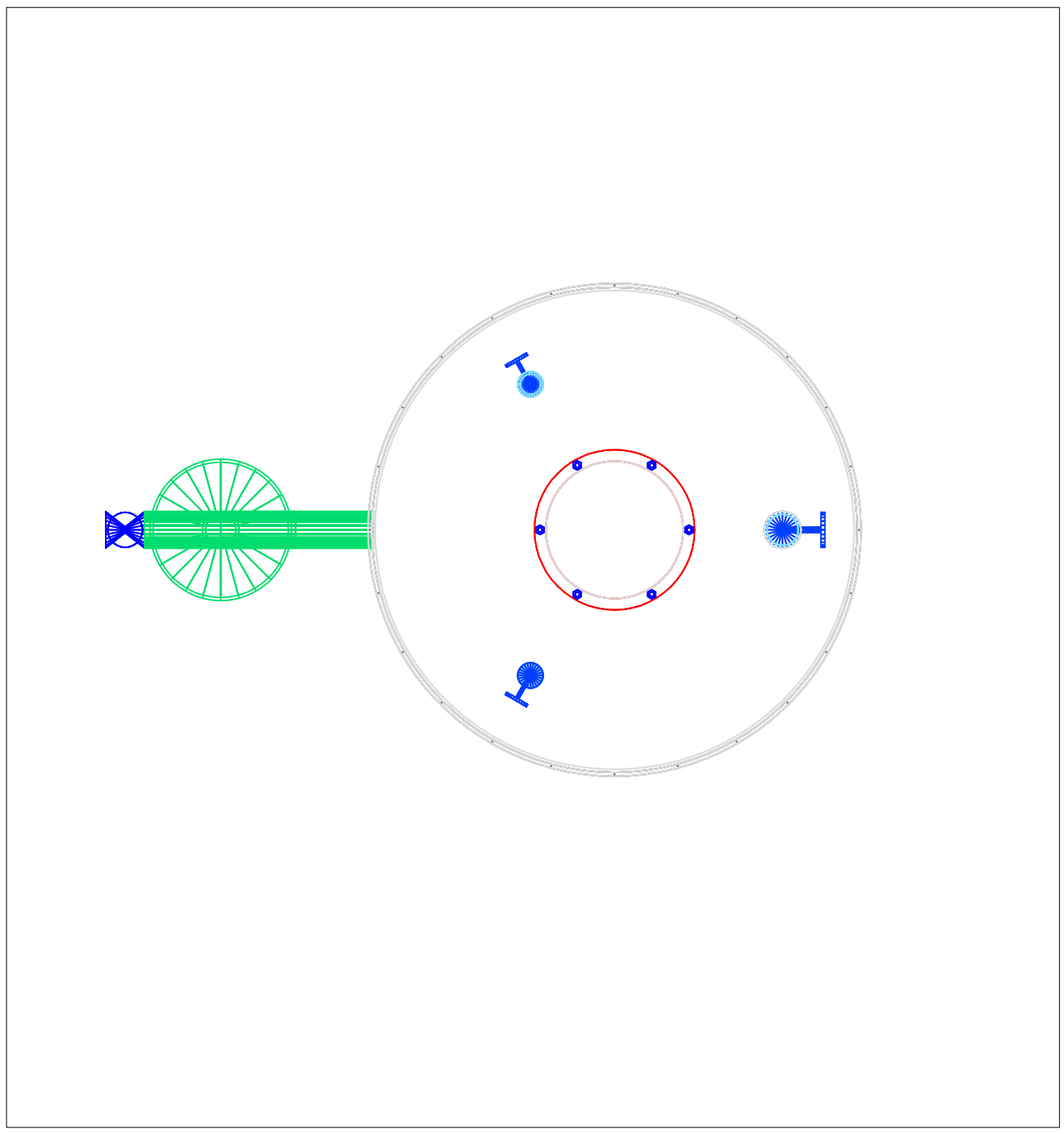
# VISTA IN PIANTA



Itemref	Quantity	Title/Name, designation, material, dimension etc			Article No./Reference	
Designed by A. Carrea	Checked by E. Arato	Approved by - date Pongiglione - 30/06/08	File name Genvap	Date 30/06/08	Scale 1:8	
	PS76 ONLUS			<b>Generatore di Vapore</b>		
010-1-I-GDV-DGC-A				Edition 0	Sheet 4/9	

1

4

1

2

3



4

RevNo	Revision note	Date	Designed	Checked	Approved

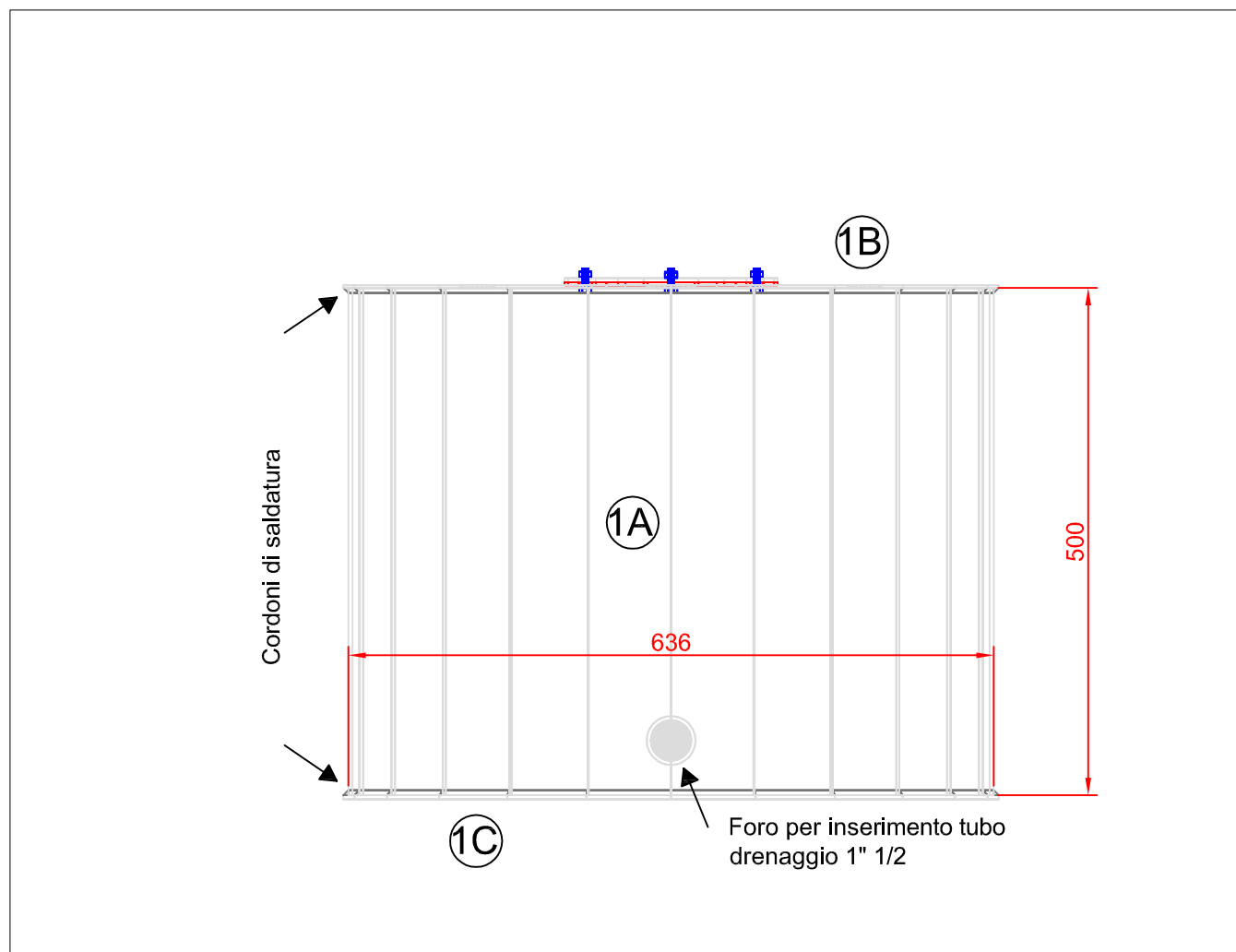
# FASCIAME



ITEM	QUANTITA'	DESCRIZIONE	NOTE
1A	1	Fasciame	Acciaio sp. 2.5 mm
1B	1	Coperchio	Vedi foglio 6
1C	1	Fondo	Acciaio sp. 2.5 mm

Itemref	Quantity	Title/Name, designation, material, dimension etc	Article No./Reference
Designed by A. Carrea	Checked by E. Arato	Approved by - date Pongiglione - 30/06/08	File name Genvap
			Date 30/06/08
			Scale 1:8
			
		<h2>Generatore di Vapore</h2>	
		010-1-I-GDV-DGC-A	Edition 0
			Sheet 5/9

1

4

1

2

3

4

RevNo	Revision note	Date	Designed	Checked	Approved

## FASCIAME (COPERCHIO)

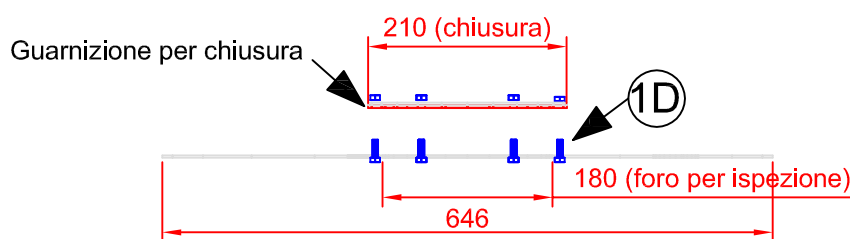
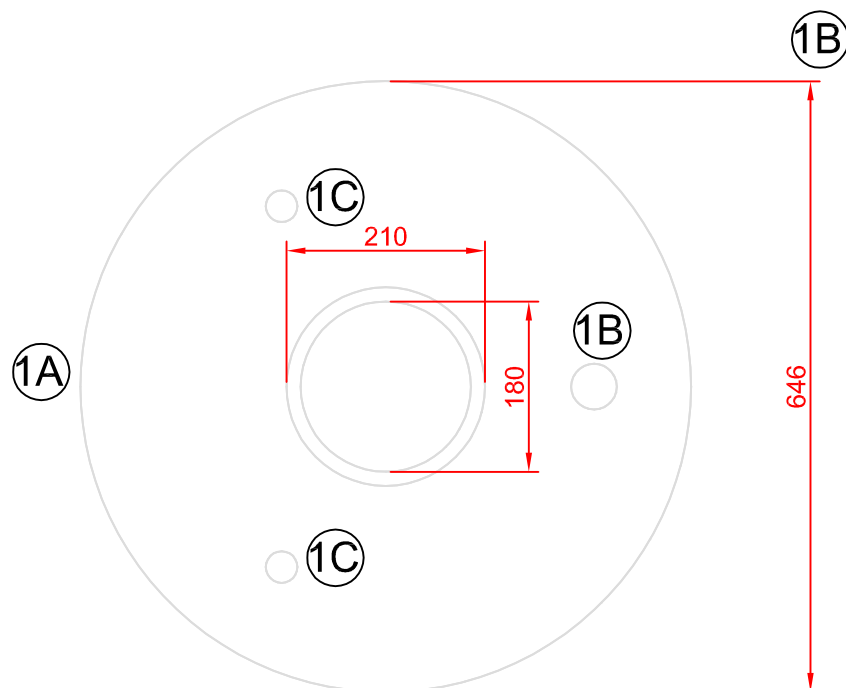

ITEM	QUANTITA'	DESCRIZIONE	NOTE
1A	1	Coperchio	Acciaio sp. 2.5 mm
1B	1	Foro per tubo 1" 1/2	
1C	2	Foro per tubo 1"	
1D	6	Bulloni M6	Nota 1

NOTE 1. La testa dei bulloni va saldata sulla faccia inferiore del coperchio prima di saldare quest'ultimo al fasciame

Itemref	Quantity	Title/Name, designation, material, dimension etc	Article No./Reference
Designed by A. Carrea	Checked by E. Arato	Approved by - date Pongiglione - 30/06/08	File name Genvap
Date 30/06/08	Scale 1:8	<h3>Generatore di Vapore</h3>	
			

1

4

1

2

3



4

RevNo	Revision note	Date	Designed	Checked	Approved

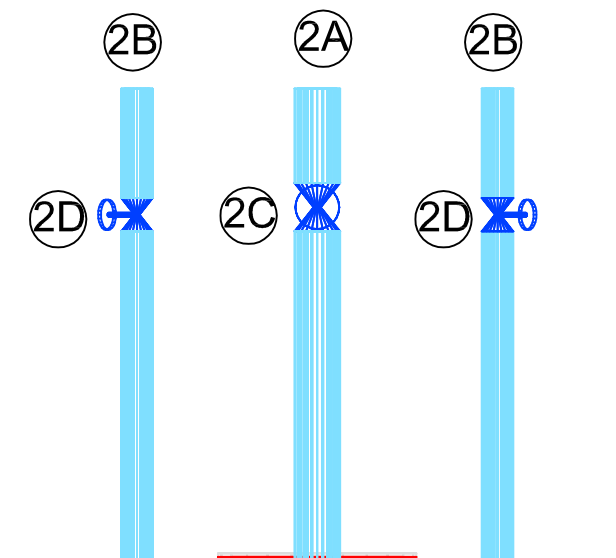
## USCITA VAPORE



ITEM	QUANTITA'	DESCRIZIONE	NOTE
2A	1	Tubo 1" 1/2	Vapore a sterilizzatore
2B	2	Tubo 1"	A chiarificatore e sfiato
2C	1	Valvola 1" 1/2	Valvola a sfera
2D	2	Valvola 1"	valvola a sfera

Itemref	Quantity	Title/Name, designation, material, dimension etc		Article No./Reference	
Designed by A. Carrea	Checked by E. Arato	Approved by - date Pongiglione - 30/06/08	File name Genvap	Date 30/06/08	Scale 1:8
 PS76 ONLUS			<b>Generatore di Vapore</b>		
			010-1-I-GDV-DGC-A	Edition 0	Sheet 7/9

1

4

1

2

3

4

RevNo Revision note

Date

Designed



Checked

Approved

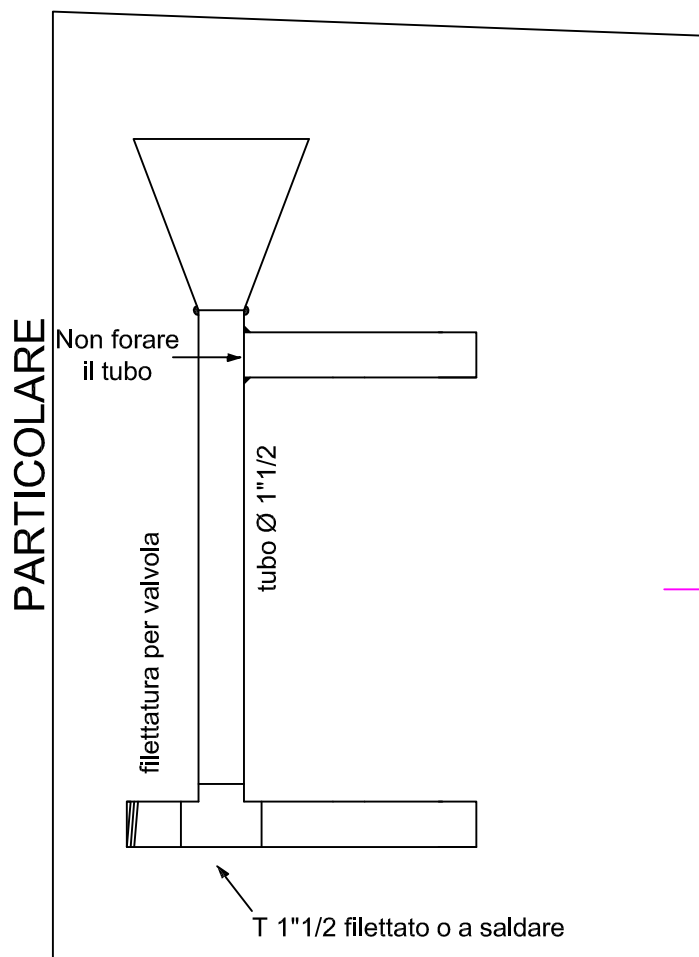
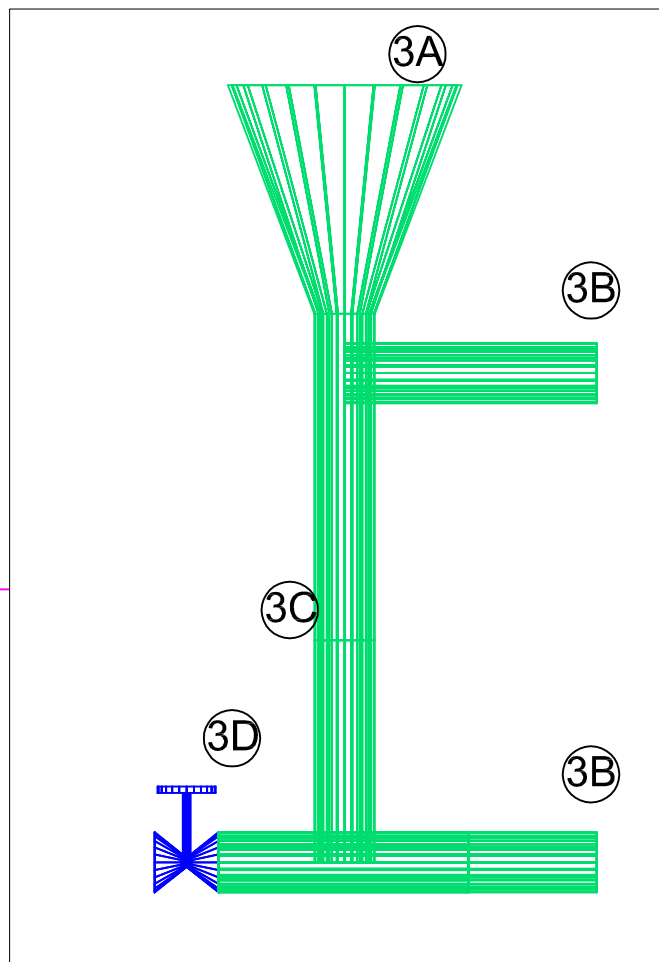
# RIEMPIMENTO, DRENAGGIO E LIVELLO



ITEM	QUANTITA'	DESCRIZIONE	NOTE
3A	1	Imbuto per riempimento	
3B	2	Tubo 1" 1/2	
2C	1	Tubo 1" 1/2	
2D	1	Valvola 1" 1/2	

Itemref	Quantity	Title/Name, designation, material, dimension etc	Article No./Reference
Designed by A. Carrea	Checked by E. Arato	Approved by - date Pongiglione - 30/06/08	File name Genvap
		Date 30/06/08	Scale 1:6
	PS76 ONLUS	 AMIGOS DA GUINE BISSAU	 DICA UNIGI
<b>Generatore di Vapore</b>			Edition 0
010-1-I-GDV-DGC-A			Sheet 8/9

1

4



1

2



3

4

RevNo	Revision note	Date	Designed	Checked	Approved

## NOTE GENERALI

1. Le dimensioni non indicate sono ricavabili dalla scala utilizzata nei singoli fogli. Esse sono comunque indicative e possono essere variate dal costruttore per rendere la costruzione più agevole
2. Lo spessore dei tubi è a piacere del costruttore

Itemref	Quantity	Title/Name, designation, material, dimension etc			Article No./Reference	
Designed by A. Carrea	Checked by E. Arato	Approved by - date Pongiglione - 30/06/08	File name Genvap	Date 30/06/08	Scale 1:6	
 PS76 ONLUS			<b>Generatore di Vapore</b>			
			010-1-I-GDV-DGC-A	Edition 0	Sheet 9/9	

1

4